

Rainbow Trout Pillow

Pattern for a 14" x 11.5"
WoolFelt Pillow



Copyright 2014
Elizabeth Coughlin

Rainbow Trout Pillow

WoolFelt Home Décor Project

Finished size is approximately 14" x 11.5"

Copyright 2014 Elizabeth Coughlin

ecoughlindesigns.blogspot.com

ecoughlindesigns.etsy.com

For personal use only, do not sell items made using these designs.

Purchase of pattern does not constitute transfer of copyright or license for commercial usage.

All Rights Reserved.

Material Sources:

WoolFelt -

National Nonwovens

P.O. Box 150 Easthampton MA 01027

1-800-333-3469

<http://www.woolfelt.com/> (wholesale)

<http://www.commonwealthfelt.com/> (online retail)

Embroidery Floss -

The DMC Corporation

10 Basin Drive, Suite 130, Kearny, NJ 07032

(973) 589-0606

<http://www.dmc-usa.com>

Materials:

- National Nonwovens WoolFelt*:
 - 12" x 18" sheet Bluer than Blue
 - 12" x 18" sheet Mint Leaf
 - 12" x 18" sheet Alluring Aqua
 - 5" x 7" piece Sunburst
 - 5" x 6" piece Rose Petal
 - 1" x 7" piece Fields of Lilacs
- DMC Color Variations Embroidery Floss (use three strands for all stitching):
 - 4215 for use with Bluer than Blue and Fields of Lilacs WoolFelts
 - 4214 for use with Sunburst WoolFelt
 - 4211 for use with Rose Petal WoolFelt
 - 4030 for use with Mint Leaf and Alluring Aqua WoolFelts
- 14.5" x 12" piece fusible fleece or batting
- 14.5" x 12" piece dark blue cotton fabric
- Thread to match fabric
- Fiberfill stuffing
- Freezer paper, iron and ironing surface, large eyed chenille needle, pen or pencil, pressing cloth, scissors, straight pins.

*Measurements are for felt used as-purchased.

You can use pre-washed felt for the project, just allow for shrinkage when purchasing materials.

All colors listed are in National Nonwovens' Zenergy WoolFelt Collection.

Instructions:

- Note: Unless otherwise indicated, use three strands embroidery floss for all stitching. Refer to the DMC website for [stitch instructions](#).
- Trace all pattern pieces onto freezer paper and cut out. Mark the joining lines on the templates as indicated.
- Place freezer paper templates shiny side down on the WoolFelt. Set the iron to the wool setting with no steam; iron must be dry. Iron the freezer paper onto the WoolFelt, pressing down for a few seconds until the freezer paper sticks.
 - Cut the water from the Alluring Aqua WoolFelt; reserve the freezer paper template.
 - Cut two (2) 2.0" x 12" strips, and two (2) 1.5" x 11.5" strips from the Bluer than Blue Wool Felt. Also cut one of each fin and the eye.
 - Cut the body from the Sunburst WoolFelt.
 - Cut the stripe from Fields of Lilacs WoolFelt.
 - Cut the head and tail from the Rose Petal WoolFelt.
 - Cut a 10" x 11.5" rectangle from the Mint Leaf WoolFelt.
- Center the blue water on the green water rectangle and pin in place. Sew close to the top and bottom edges with the 4030 floss and a running stitch as shown in Figure A.
- Center the trout body on the water, and pin. Sew with a blanket stitch and the 4214 floss.

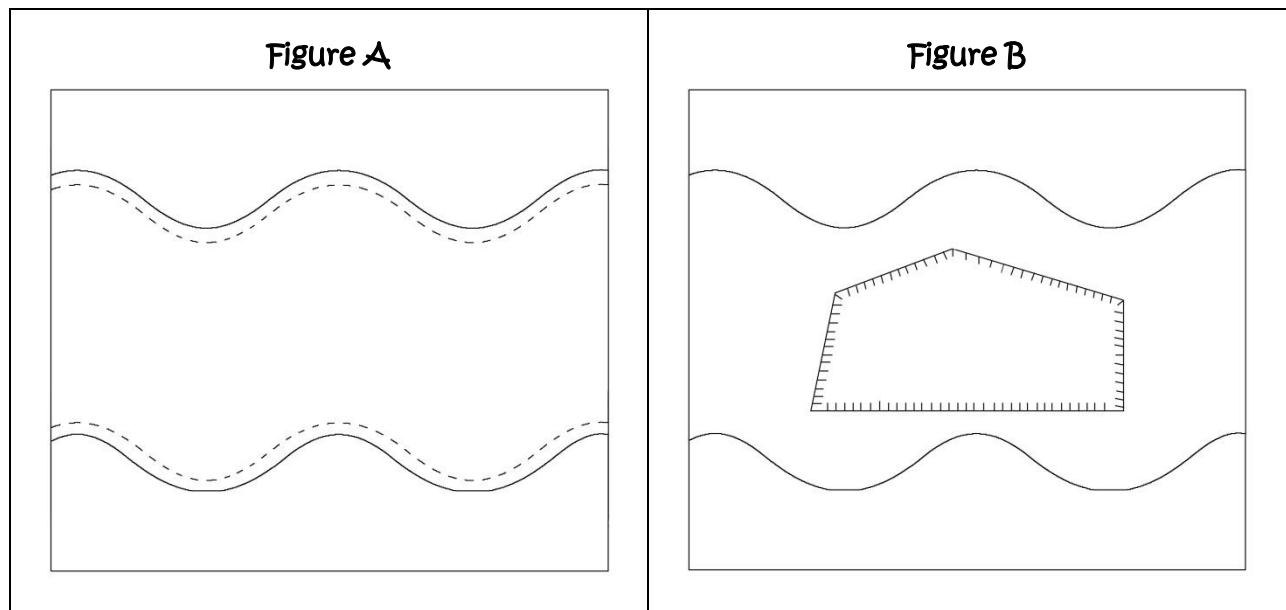

- With the 4215 floss, attach the eye to the trout head as shown in Figure C.
- Pin the head next to the body, matching the join lines on your pattern pieces. With the 4211 floss, blanket stitch the head to the pillow top, interlocking the stitches where the head meets the body. (See Figure D.)

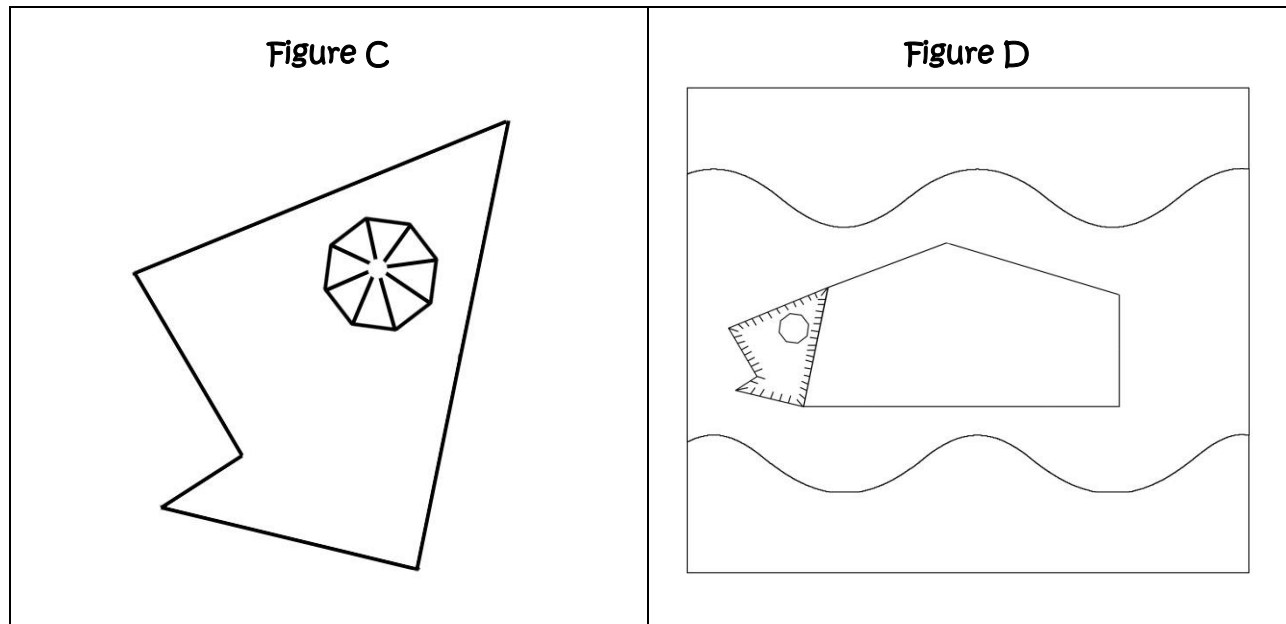

- Pin the tail next to the body, matching the join lines on your pattern pieces. With the 4211 floss, blanket stitch the tail to the pillow top, interlocking the stitches where the tail meets the body. (See Figure E.)
- Pin the fins next to the body, matching the join lines on your pattern pieces. With the 4215 floss, blanket stitch the fins to the pillow top, interlocking the stitches where they meet the body. (See Figure F.)

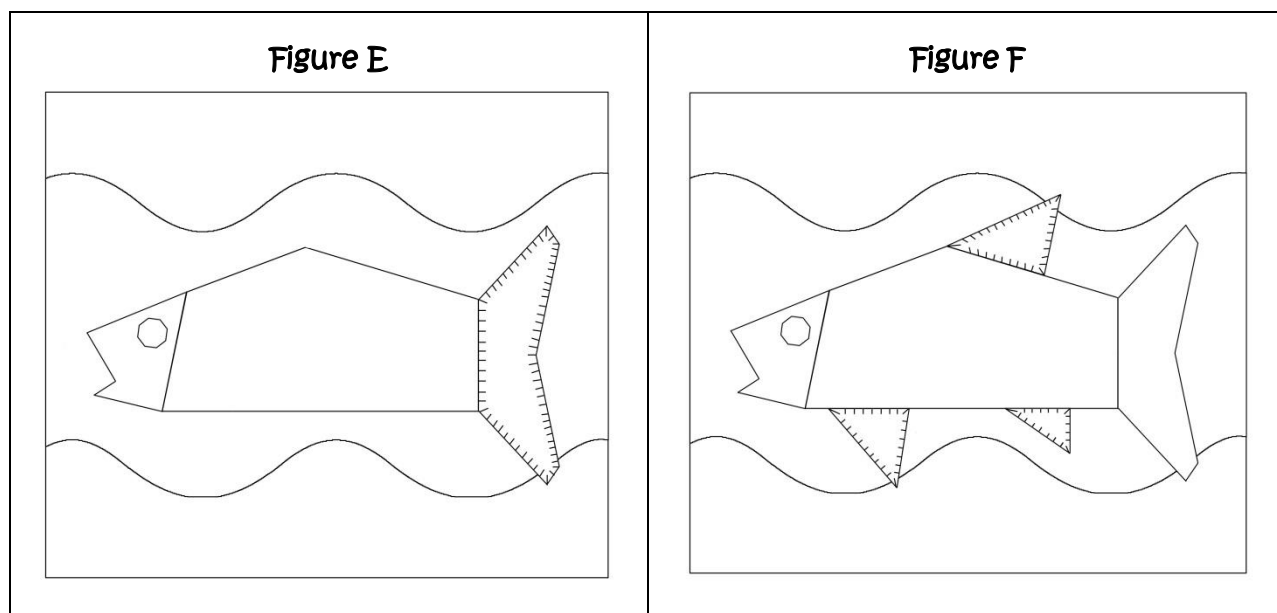

- Pin the stripe on top of the body, lining up the angled sides. Attach with the 4215 floss and a fly stitch as shown in Figure G.
- With matching thread and a ¼" seam on your sewing machine, attach the 1.5" x 11.5" Blueer than Blue WoolFelt strips to the top and bottom. (See Figure H.)

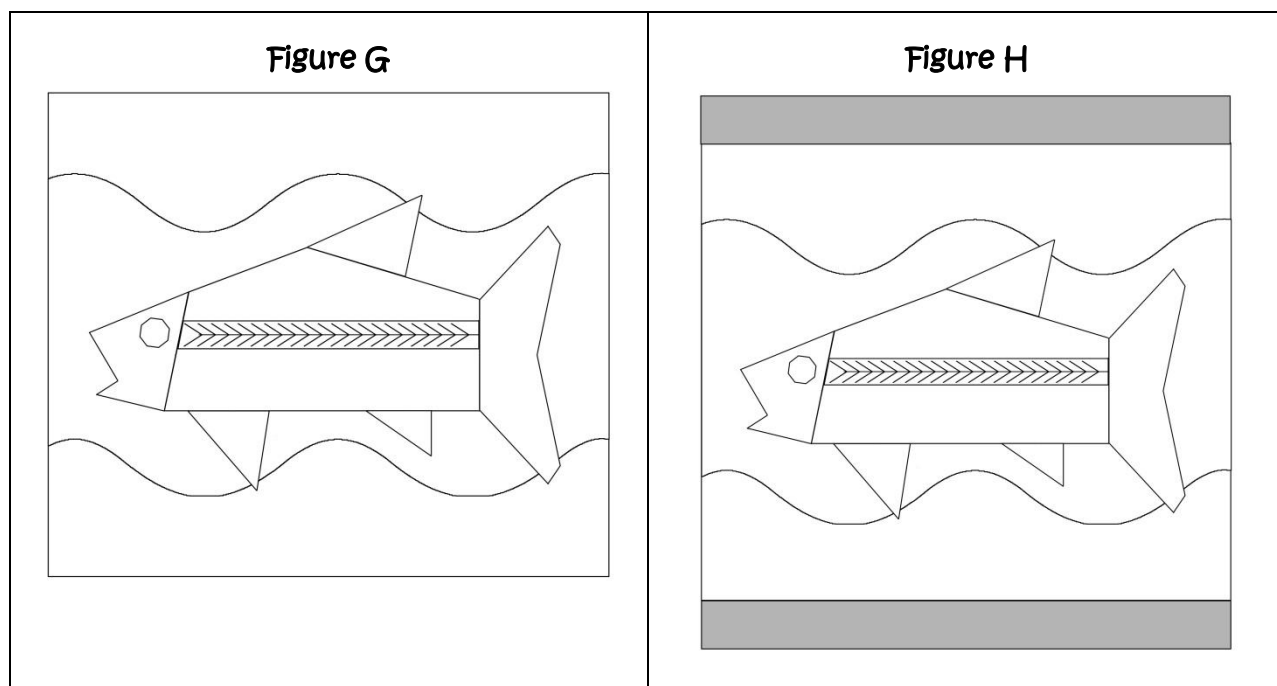

- With matching thread and a $\frac{1}{4}$ " seam on your sewing machine, attach the 2" x 12" Blue than Blue WoolFelt strips to the sides. (See Figure I.)
- If using fusible fleece, adhere the 14.5" x 12" piece to the wrong side of the 14.5" x 12" piece of dark blue fabric, following manufacturers' instructions. If using batting, place it behind the fabric and pin. Quilt the fabric/fleece or fabric/batting, using the edge of the reserved water freezer paper template as a guide. Quilt by machine or hand. (I used the 4215 floss and a hand-running stitch, shown in Figure J.)

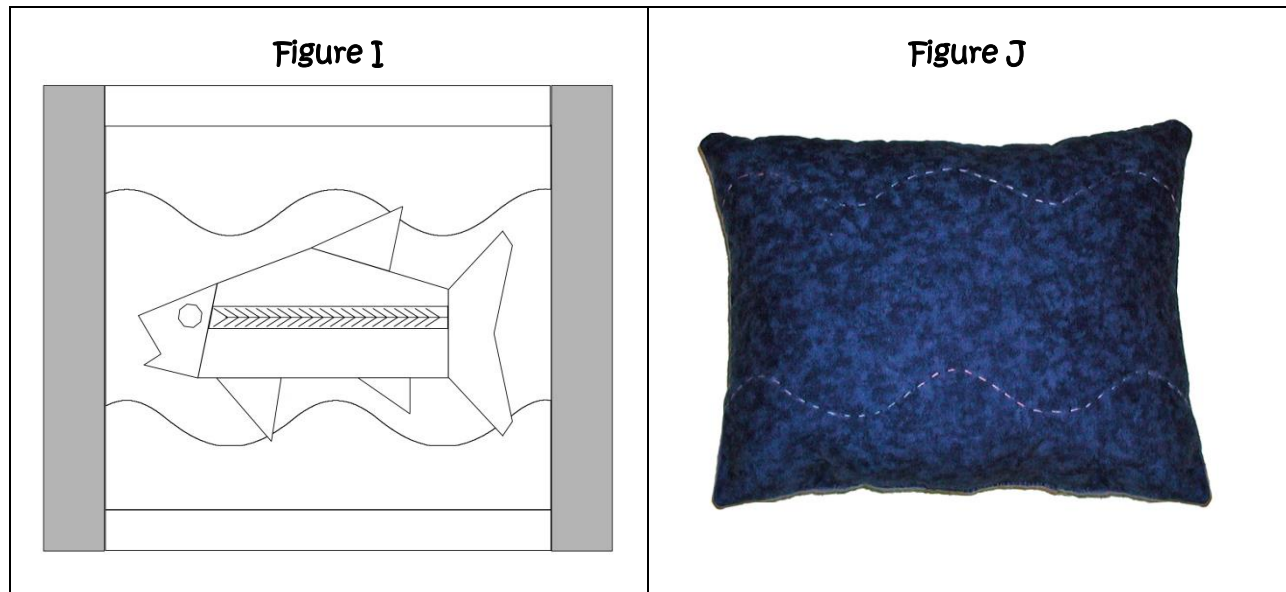

- With an iron on the wool setting, and using a pressing cloth, press both the pillow top and the fabric backing.
- Pin right sides together and stitch around the edges with a $\frac{1}{4}$ " seam on you sewing machine, leaving a 5" opening at the bottom of the pillow. Then, go back and sew diagonally across the corners, approximately $\frac{1}{2}$ " from point. Turn pillow, firmly stuff with fiberfill, and hand-whip stitch the opening closed with the matching thread.
- Finished size is of pillow is approximately 14" x 11.5"

Patterns

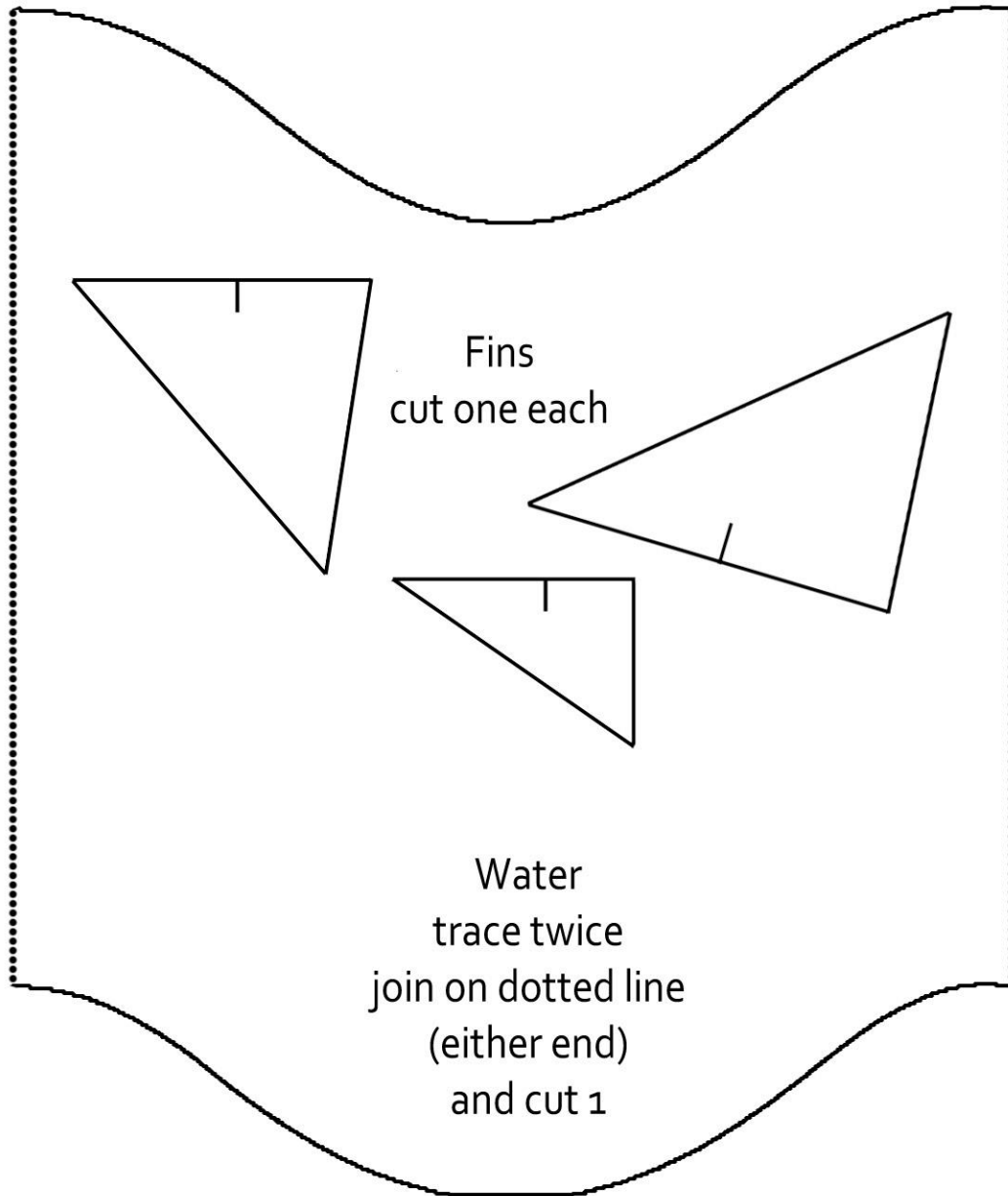

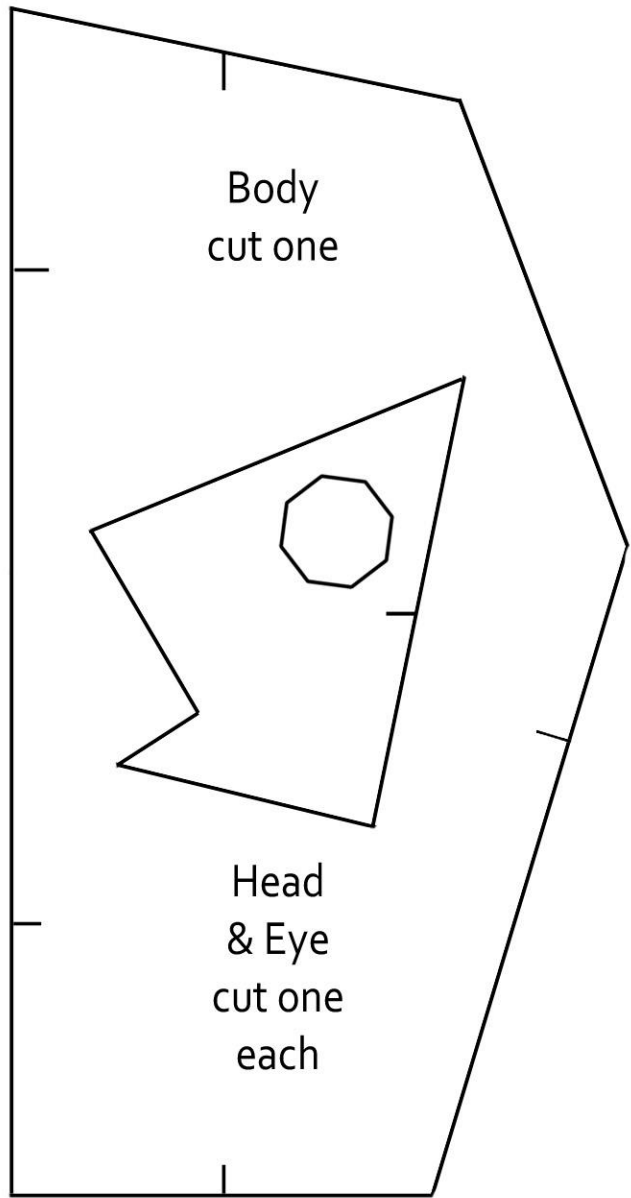

Stripe
cut one

